

BATTERY POWER INVERTERS



12V Pure Sine Wave Inverter Manual

1000W | 2000W

Version 2.0





Important Safety Instructions



Please save these instructions.

This manual contains important safety, installation, and operating instructions for the inverter. The following symbols are used throughout the manual:

WARNING

Indicates a potentially dangerous condition. Use extreme caution when performing this task.

CAUTION

Indicates a critical procedure for safe and proper operation of the inverter.

NOTE

Indicates a procedure or function that is important to the safe and proper operation of the inverter.

■ General Safety Information

- Installation and wiring must comply with the Local and National Electric Codes (NEC) and must be done by a certified technician.
- Read all of the instructions and cautions in the manual before beginning the installation.
- There are no serviceable parts for this inverter. Do NOT disassemble or attempt to repair the inverter. Make sure all connections going into and from the inverter are tight. There may be sparks
- when making connections, therefore, make sure there are not flammable materials or gases near installation.

■ Inverter Safety

- The inverters are suitable for 12V Battery Banks ONLY.
- ALWAYS make sure inverter is in OFF position and disconnect all AC and DC connecting when working on any circuit associated with the inverter.
- NEVER connect the AC output of the unit directly to an Electrical Breaker Panel/ Load Centre which is also fed from the utility power / generator.
- When connecting battery terminals, ensure the polarity of the battery connections is correct. Incorrect polarity may cause permanent damage to the unit.
- Be careful when touching bare terminals of capacitors as they may retain high lethal voltages even after power is removed.

■ Battery Safety

- Do NOT let the positive (+) and negative (-) terminals of the battery touch each other.
- Use only sealed lead-acid, flooded, or gel batteries which must be deep cycle.
- Explosive battery gases may be present while charging. Be certain there is enough ventilation to release the gases.
- Be careful when working with large lead acid batteries. Wear eye protection and have fresh water available in case there is contact with the battery acid.
- Over-charging and excessive gas precipitation may damage the battery plates and activate material shedding on them. Too high of an equalizing charge or too long of one may cause damage. Please carefully review the specific requirements of the battery used in the system.

■ Installation Safety

- The unit should be installed in a well-ventilated, cool, and dry environment. Make sure the fans of the unit and the ventilation holes are not blocked.
- Do not expose the unit to rain, moisture, snow, or liquids of any type.

Table of Contents

General Information	04
Included Components	05
Identification of Parts (AC Side)	06
Identification of Parts (DC Side)	08
Dimensions	09
Installation	10
Location Recommendations	10
Sizing a Battery Bank	11
Grounding	11
DC Side Connection	12
Recommended Fusing	13
Operation	13
AC Side Operation	13
Eco Power Saving Mode Instruction	14
Inverter Troubleshooting	14
Specifications	15

General Information

The Renogy Pure Sine Wave Power Inverter delivers superior performance for remote off-grid applications, capable of producing cleaner, smoother, and more reliable electricity for a user's electronic needs.

■ Key Features

- Robust and sleek design
- Pure sine wave output (THD<3%)
- Excellent Surge Rating:2x the Power Rating
- Optimized for 12VDC system voltage
- Easy-to-read LED indicator display
- Multiple protection features(LVD,HVD,AC Overload and Over Temperature)
- Clean power for safe operation of sensitive electronics
- Power Saving Mode to conserve energy

■ Pure Sine Wave

The Renogy Power Inverters output a pure sine wave similar to the waveform of the grid power. In a pure sine wave, the voltage rises and falls in a smooth fashion with very low harmonic distortion and cleaner utility-like power.

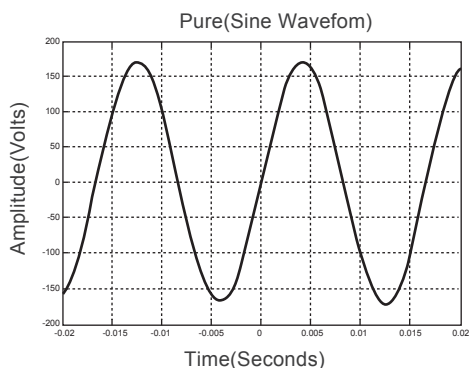

This gives users stable enough power to operate tools, fans, lights, computers, and other electronics without any interference. Pure sine wave inverters are in many cases more efficient, allowing users to use less energy and allow for more device capability. The main advantage to pure sine wave inverters is that they are used to operate sensitive electronic devices that require a high quality waveform with little harmonic distortion. Almost any electronic device could be powered using a pure sine wave inverter.

Included Components

The Renogy Pure Sine Wave Battery Inverters will be shipped with inverter cables and a remote control for powering the inverter on or off.

Inverter Model	Gauge
1000W	4 AWG
2000W	4 AWG * 2



Wired remote control

List dimensions	2.88 x 2.31 x .94in / 73 x 58.7 x 23mm
Thickness	0.63in / 1.5mm
Wire length	Approx 19.8ft

Identification of Parts (AC Side)

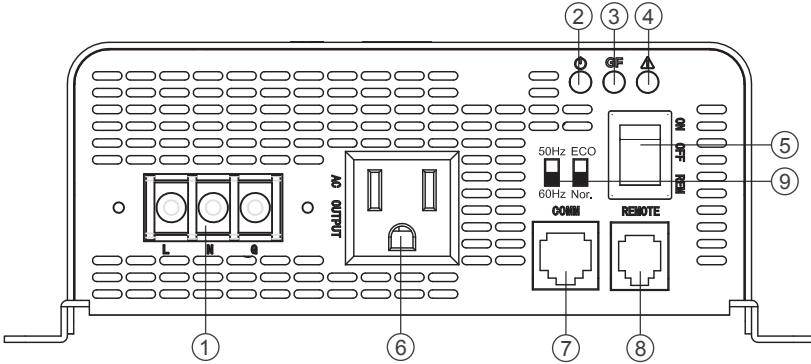

Figure 2: 1000W Inverter

Key Parts

- AC Terminal Block** — Use the terminal block to utilize the full wattage in 110V AC 60Hz. Remove the two screws on protective cover to access the terminals. Any AC output wiring that is directly connected must comply with US National Electric Code (NEC) wiring gauge recommendations.

Inverter Model	Use Terminal Block
1000W	Use the full 1000W (Approx 8.3A)
2000W	Use the full 2000W (Approx to 16A)

● **Facing the front panel, the terminals are:**

LEFT	Middle	Right
Live(L)	Neutral (N)	Ground(G)

NEUTRAL and GROUND are bonded inside the inverter to comply with the National Electric Code (NEC) requirement that any AC source must have a neutral to ground connection.

- 2. Power LED (Green)** — When this green LED is lit, the inverter is operating.
— When this green LED is flashing, the inverter is in ECO power saving mode.
- 3. GFCI LED (Yellow)** — When the yellow LED is lit, the ground fault circuit has been interrupted.
Shut down the inverter and restart.
- 4. Fault LED (Red)** — The red indicator turns on as the inverter shuts down due to overheating, overload, under voltage, or over voltage.
 - Immediately turn off all AC appliances if the Fault LED is lit. Allow the inverter to cool before continuing. Make sure that the ventilation vents are not blocked.
 - If an inverter shutdown was preceded by a buzzing sound, there may be an excessive load in combination with low voltage or a cable problem.
- 5. ON/OFF Switch** — Controls AC Output and Remote feature
- 6. AC Outlets** — Up to 8.3 amps (1000W), Up to 15 amps (2000W) at 110V AC 60 Hz.
- 7. Communication Port**—RS485, data transmission
- 8. Remote Switch Connection** — Insert wired remote switch to the connection port. Set ON/OFF switch to "remote" position.
- 9. 50Hz/60Hz-** Switches between 50Hz and 60Hz
Eco/Nor- Switches between Energy Saving mode and Normal mode

NOTE **Alarm** —If there is a buzzing sound, the battery is low. The user should reduce the AC load, charge the battery, and check the DC cable for excessive losses.

Identification of Parts (DC Side)

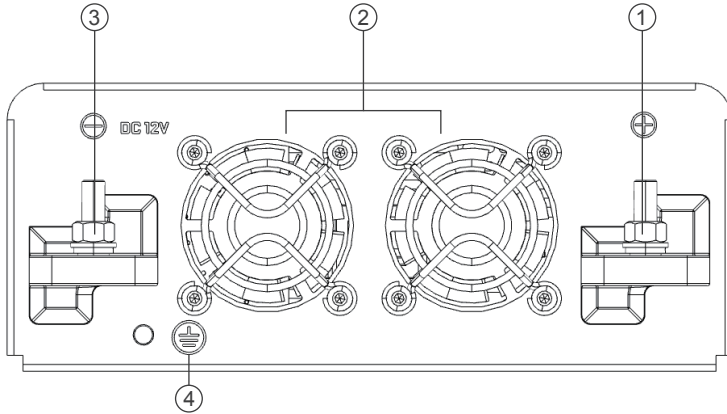

Figure 3: 1000W Inverter

■ KEY PARTS

- 1. Positive Terminal** — Positive (+) DC Input (Red)
- 2. Cooling Fans** — Thermally controlled
- 3. Negative Terminal** — Negative (-) DC Input (Black)
- 4. Ground Terminal** — For insulated safety ground wire.

Dimensions

1000W

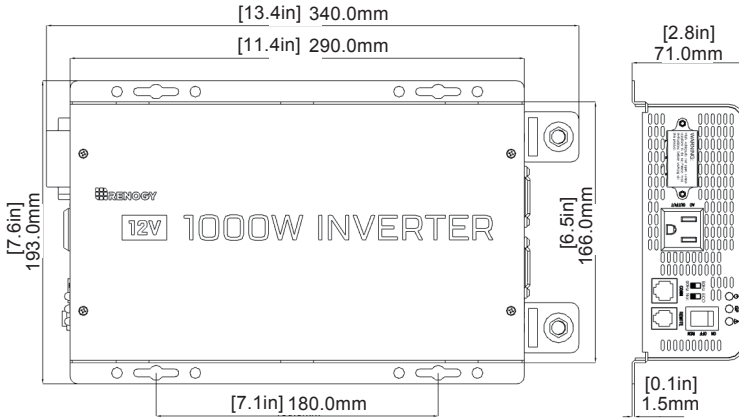

2000W

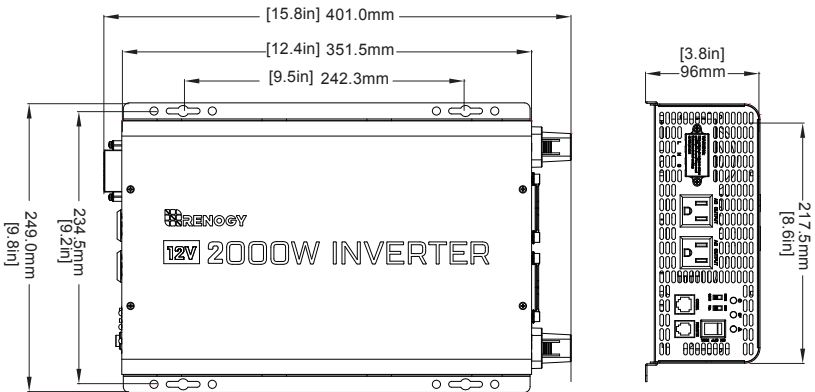

Installation

WARNING Make sure inverter is in the off position before connecting anything.

CAUTION Do not over-torque or over tighten the terminals. This could potentially damage the unit.

CAUTION Refer to the technical specifications for max wire sizes on the controller and for the maximum amperage going through wires.

Location Recommendations

WARNING Never install the inverter in a sealed enclosure with flooded batteries. Gas can accumulate and there is a risk of explosion.

Ensure installation follows the following guidelines:

1. **Cool, dry, well-ventilated area** — Heat is the worst enemy for electronic equipment. Inverters must be in an area where the fans are not blocked or where they are not hit directly by the sun. They should be in an area free of any kind of moisture and allow for clearance of at least 10" around the unit to provide for adequate ventilation.
2. **Protection against fire hazard** — the unit should be away from any flammable material, liquids, or any other combustible material. The unit can spark and the consequences could be severe.
3. **Close proximity to battery bank**—prevent excessive voltage drop by keeping the unit close to the battery bank and having a properly sized wire going from the battery bank to the inverter.
4. **WARNING** **Do not install the inverter in the same compartment as the battery bank because it could serve as a potential fire hazard.**
5. **Limiting electromagnetic interference (EMI)** — ensure the inverter is firmly grounded to a building, vehicle, or earth grounded. Keep the inverter away from EMI receptors such as TVs, radios, and other audio/visual electronics to prevent damage/interference to the equipment.
6. **Secure inverter**—the inverter could be stand alone or mounted using the outlying terminals on the inverter.

WARNING **The inverter should never be mounted vertically on a vertical surface since it would present a hazard for the fan opening which is crucial for cooling the inverter.**

■ Sizing a Battery Bank

- **Determine the amount of Watts (Amps * Volts) for the load, and how long the load needs to operate**—each electrical appliance has technical specifications indicating the watts, or the volts and amps required for operation.
- **Estimate load run-time**—Battery size depends on load watts and run-time. Most loads are not constant, so estimation is very important.
- **Utilize the formula Watts = Volts * Amps**
- **Determine Amps used for how many hours – Amp-hour (Ah)**

For this Renogy inverter, the battery bank will be 12 volts direct current (12 VDC)

Example	
A Microwave oven = 700 Watts 12V battery bank	700 Watts to run microwave oven using the batteries as if it was a 12VDC microwave requires 58 Amps $700 \text{ Watts} / 12 \text{ Volts} = 58 \text{ Amps}$
Load Operation = 3 hours	Now that amps have been determined, the amp-hours need to be determined. The microwave will be used for approximately 3 hours a day. $58 \text{ Amps} * 3 \text{ hours} = \underline{174 \text{ Ah}}$
At least a 174 Ah battery must be selected in order to use the 700-Watt microwave at 3 hours a day. However, determining a battery size is also dependent on the battery that is able to handle repeated discharge/charge cycles.	

NOTE

This is just an example. Actual quantities vary by battery capacity and rates of discharge.

To power the microwave in the example, the user must use an inverter that is at least 1000 watts, if not more.

■ Grounding

The Renogy Pure Sine Wave inverters come equipped with a grounding lug to appropriately ground to earth or to another designated ground (for example, a metal frame of an RV). The connections to ground must be tight and against bare metal. Whether using the inverter in a mobile application, such as an RV, or in a building, grounding is highly recommended. The recommended wire size for grounding is 10 AWG insulated copper strand wire. For more information regarding grounding, users and/or installers must consult with the Local and National Electric Codes (NEC) for more specific grounding regulations and suggestions as they can change per scenario.

DC Side Connection

WARNING

The Renogy Pure Sine Wave Inverters are suitable for 12V battery bank systems **ONLY**. Not following the minimum DC requirement will cause irreversible damage to the unit.

CAUTION

Be careful of the positive and negative poles. Reversing the poles might cause permanent damage to the inverter. It will surely blow the internal fuse.

NOTE

Damage to the Renogy inverters due to reverse polarity is **NOT** covered by warranty.

The input terminals of the inverters have large capacitors connected to them. Once a positive and negative wire are connected to the terminals, it will complete the circuit, and commence drawing a heavy current momentarily. As a result, there may be a sparking occurring even if the inverter is in the off position. To minimize sparking, it is recommended that the user have the appropriate size wire feeding into the inverters and/or install an external fuse leading into the inverter.

1. Flip inverter power to OFF position (on AC side)

2. Remove Cap, then unscrew inverter terminals and connect battery connections. Then tighten.

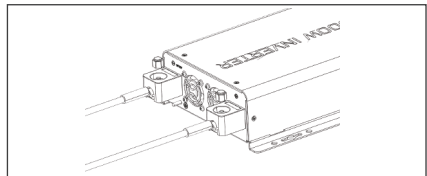
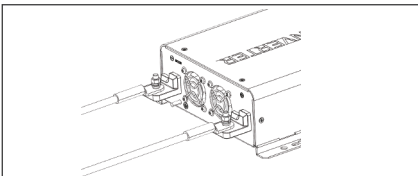
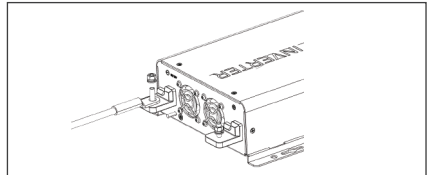
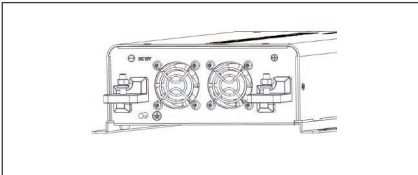
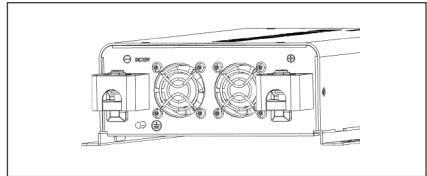
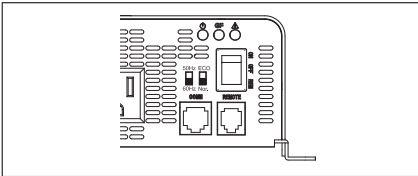

■ Recommended Fusing

The following are recommended fuse sizing

Inverter Model	Fuse
1000W	100A
2000W	200A

Operation

Assuming proper battery connection, the inverter is now ready for use.

■ AC Side Operation

1. Connect electronic devices to electrical socket(s) on inverter. Flip inverter power to ON position (on AC side)
2. When finished, switch AC devices off FIRST, then turn off inverter switch

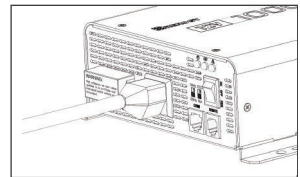

CAUTION

Avoid switching on the inverter with the load (electronic devices) already switched on. This may trigger an overload since some electronic devices have an initial high power surge to start.

CAUTION

When switching off the inverter, turn off the electronic devices first. Although the inverter is off, the capacitors will still have a charge, so the DC and AC terminals must be disconnected if altering the circuitry.

■ Eco Power Saving Mode Instruction

This inverter features a power saving mode to conserve battery power. To enable this function, set the DIP switch to ECO. Please note, the DIP Switch for the mode needs to be set BEFORE turning on the inverter.

Under power saving mode the inverter senses the output power being drawn. It shuts down the output power and remains on standby with lower idle consumption if the AC load is less than 50 watts.

The inverter will send a pulse once every 3 seconds to look for AC load. You will also notice the power light start to pulse, indicating ECO mode. If the inverter detects a load greater than 50 watts it will automatically start inverting, restores the output to power the load. When all loads are turned off the inverter will go back into search mode.

Inverter Troubleshooting

Indicator	Potential Issue	Troubleshoot	
Fault LED Lit and alarm beeps	Input voltage is below 11V	Keep input voltage above 11V	
	Input voltage is above 15V	Keep input voltage below 15V	
Fault LED Lit, Inverter Shut Down and alarm on	Input voltage is below 10.5V	Keep input voltage above 10.5V	
	Input voltage is above 15.5V	Keep input voltage below 15.5V	
	Inverter overheats		Allow inverter to cool down
			Check for adequate ventilation
			Reduce the load on inverter
	Operating equipment draws too much power	Use a higher wattage inverter or use a lower powered device	
Inverter is short circuited	Disconnect the inverter and turn off the ON/OFF switch to reset		
Yellow LED Lit - Inverter shut down	GFCI tripped	Disconnect appliances and turn off the ON/OFF switch to reset	

Specifications

Model	PGH1-10111S	PGH1-20111S
Continuous Power	1000 W	2000 W
Input Voltage	12V DC	
Output Voltage	110V AC +/- 10%	
Peak Surge	2000 W	4000 W
Efficiency	> 90%	
Frequency	50/60Hz	
Total Harmonic Distortion	< 3%	
No Load Consumption	< 1.0A	< 2.0A
Battery Low Voltage Alarm	10.5V ± 0.5V DC	
Low Voltage Shutdown	10.0V ± 0.5V DC	
High Voltage Disconnect	15.5V ± 0.5V DC	
Cooling	Thermally controlled fans	
AC Sockets	1	2
Temperature Range	-4°F - 158°F / -20°C - 70°C	
Power Output Control	Inverter Power Switch, Remote	
Dimensions	13.4 x 7.6 x 2.8 in 340 x 193 x 71mm	15.8 x 9.8 x 3.8in 401 x 249 x 96mm
Weight	7.5 lbs / 3.4 kg	10.4 lbs / 4.7 kg
Certification	FCC Part 15 class B	

Wired Remote Control





List dimensions	2.88 x 2.31 x .94in / 73 x 58.7 x 23mm
Thickness	0.63in / 1.5mm
Wire length	Approx 19.8ft

This equipment has been tested and found to comply with the limits for a class B digital device, pursuant to part 15 of the FCC Rules. These limits are designed to provide reasonable protection against harmful interference in a residential installation. This equipment generates, uses and can radiate radio frequency energy and if not installed and used in accordance with the instructions, may cause harmful interference to radio communications. However, there is no guarantee that interference will not occur in a particular installation. If this equipment does cause harmful interference to radio or television reception, which can be determined by turning the equipment off and on, the user is encouraged to try to correct the interference by one or more of the following measures:

- Reorient or relocate the receiving antenna.
- Increase the separation between the equipment and receiver.
- Connect the equipment into an outlet on a circuit different from that to which the receiver is connected.
- Consult the dealer or an experienced radio/TV technician for help.



This device complies with Part 15 of the FCC Rules. Operation is subject to the following two conditions: (1) this device may not cause harmful interference, and (2) this device must accept any interference received, including interference that may cause undesired operation.

Renogy reserves the right to change the contents of this manual without notice.



US |  2775 E Philadelphia St, Ontario, CA 91761, USA
 909-287-7111
 www.renogy.com
 support@renogy.com

CN |  苏州高新区科技城培源路1号5号楼-4
 400-6636-695
 <https://www.renogy.cn>
 support@renogy.cn

JP |  <https://www.renogy.jp>
 supportjp@renogy.com

CA |  <https://ca.renogy.com>
 supportca@renogy.com

AU |  <https://au.renogy.com>
 supportau@renogy.com

UK |  <https://uk.renogy.com>
 supportuk@renogy.com

DE |  <https://de.renogy.com>
 supportde@renogy.com