

Wanderer

10A PWM

Solar Charge Controller

Version 1.0



 **RENOGY**

Important Safety Instructions

Please save these instructions.

This manual contains important safety, installation, and operating instructions for the charge controller. The following symbols are used throughout the manual:

WARNING

Indicates a potentially dangerous condition. Use extreme caution when performing this task.

CAUTION

Indicates a critical procedure for safe and proper operation of the controller

NOTE

Indicates a procedure or function that is important to the safe and proper operation of the controller.

■ General Safety Information

- Read **all** of the instructions and cautions in the manual before beginning the installation.
- There are no serviceable parts for this controller. Do **NOT** disassemble or attempt to repair the controller.
- Make sure **all** connections going into and from the controller are tight. There may be sparks when making connections, therefore, make sure there are not flammable materials or gases near installation.

■ Charge Controller Safety

- **NEVER** connect the solar panel array to the controller without a battery. Battery must be connected first. This may cause a dangerous occurrence where the controller would experience a high open circuit voltage at the terminals.
- Ensure input voltage does not exceed **50 VDC** to prevent permanent damage. Use the Open Circuit (Voc) to make sure the voltage does not exceed this value when connecting panels together in series.

- The charge controller should be installed indoors in a well-ventilated, cool, and dry environment.
- Do NOT allow water to enter the controller.

■ Battery Safety

- Do NOT let the positive (+) and negative (-) terminals of the battery touch each other.
- Use only sealed lead-acid, flooded, gel or lithium batteries which must be deep cycle.
- Explosive battery gases may be present while charging. Be certain there is enough ventilation to release the gases.
- Be careful when working with large lead acid batteries. Wear eye protection and have fresh water available in case there is contact with the battery acid.
- Over-charging and excessive gas precipitation may damage the battery plates and activate material shedding on them. Too high of an equalizing charge or too long of one may cause damage. Please carefully review the specific requirements of the battery used in the system.
- Equalization is carried out only for non-sealed / vented / flooded / wet cell lead acid batteries.
- Do NOT equalize VRLA type AGM / GEL / LITHIUM batteries UNLESS permitted by battery manufacturer.

WARNING

Connect battery terminals to the charge controller BEFORE connecting the solar panel (s) to the charge controller. NEVER connect solar panels to charge controller until the battery is connected.

Table of Contents

General Information	04
Identification of Parts	07
Installation	07
Wiring	08
Operation	12
Wanderer Protections	16
Maintenance	18
Fusing	19
Technical Specifications	20
Battery Charging Parameters	21
Dimensions	22

General Information

The Wanderer is an advanced charge controller for off-grid solar applications. Integrating highly efficient PWM charging, this controller increases battery life and improves system performance. It can be used for 12V/24V battery banks. The controller is embedded with self-diagnostics and electronic protection functions that prevent damages from installation mistakes or system faults.

Key Features

- Automatically detects 12V or 24V DC system voltages, 10A Charging Capacity
- Deep Cycle Sealed, Gel and Flooded battery options
- 4 Stage PWM charging: Bulk, Boost, Float, and Equalization
- Temperature compensation and correcting the charging and discharging parameters automatically, improving battery lifetime
- Protection against: overcharging, over current, short-circuit, reverse current and reverse polarity
- Backlit LCD screen for displaying system operation, diverse load control and error codes
- Integrated 5V 2A USB ports for extra charging
- Integrated communication port for remote monitoring
- Charges over-discharged lithium-ion batteries
- Negative ground charge controller

PWM Technology

The Wanderer utilizes Pulse Width Modulation (PWM) technology for battery charging. Battery charging is a current based process so controlling the current will control the battery voltage. For the most accurate return of capacity, and for the prevention of excessive gassing pressure, the battery is required to be controlled by specified voltage regulation set points for Absorption, Float, and Equalization charging stages. The charge controller uses automatic duty cycle conversion, creating pulses of current to charge the battery.

The duty cycle is proportional to the difference between the sensed battery voltage and the specified voltage regulation set point. Once the battery reached the specified voltage range, pulse current charging mode allows the battery to react and allows for an acceptable rate of charge for the battery level.

Four Charging Stages

The Wanderer has a 4-stage battery charging algorithm for a rapid, efficient, and safe battery charging. They include: Bulk Charge, Boost Charge, Float Charge, and Equalization.

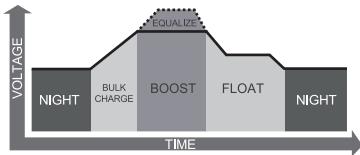

Bulk Charge: This algorithm is used for day to day charging. It uses 100% of available solar power to recharge the battery and is equivalent to constant current.

Boost Charge: When the battery has charged to the Boost voltage set-point, it undergoes an absorption stage which is equivalent to constant voltage regulation to prevent heating and excessive gassing in the battery. The Boost time is 120 minutes.

Float Charge: After Boost Charge, the controller will reduce the battery voltage to a float voltage set point. Once the battery is fully charged, there will be no more chemical reactions and all the charge current would turn into heat or gas. Because of this, the charge controller will reduce the voltage charge to smaller quantity, while lightly charging the battery. The purpose for this is to offset the power consumption while maintaining a full battery storage capacity.

In the event that a load drawn from the battery exceeds the charge current, the controller will no longer be able to maintain the battery to a Float set point and the controller will end the float charge stage and refer back to bulk charging.

Equalization: Is carried out every 28 days of the month. It is intentional overcharging of the battery for a controlled period. Certain types of batteries benefit from periodic equalizing charge, which can stir the electrolyte, balance battery voltage and complete chemical reaction. Equalizing charge increases the battery voltage, higher than the standard complement voltage, which gasifies the battery electrolyte.

WARNING

Once equalization is active in the battery charging, it will not exit this stage unless there is adequate charging current from the solar panel. There should be NO load on the batteries when in equalization charging stage.

Over-charging and excessive gas precipitation may damage the battery plates and activate material shedding on them. Too high of equalizing charge or for too long may cause damage. Please carefully review the specific requirements of the battery used in the system.

Lithium Battery Activation

The Wanderer PWM charge controller has a reactivation feature to awaken a sleeping lithium battery. The protection circuit of Li-ion battery will typically turn the battery off and make it unusable if over-discharged. This can happen when storing a Li-ion pack in a discharged state for any length of time as self-discharge would gradually deplete the remaining charge. Without the wake-up feature to activate and charge batteries, these batteries would become unserviceable and the packs would be discarded. The Wanderer will apply a small charge current to activate the protection circuit and if a correct cell voltage can be reached, it starts a normal charge.

Identification of Parts

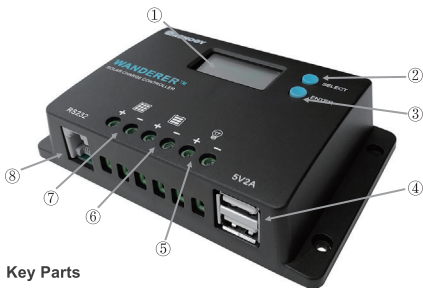

Key Parts

- ① LCD Screen
- ② Select Button
- ③ Enter Button
- ④ USB Ports
- ⑤ Load Terminals
- ⑥ Battery Terminals
- ⑦ PV Terminals
- ⑧ RS232 Communication Port

Installation

WARNING

Connect battery terminal wires to the charge controller **FIRST**, then connect the solar panel(s) to the charge controller. **NEVER** connect solar panel to charge controller before the battery.

CAUTION

Do not over-torque or over tighten the screw terminals. This could potentially break the piece that holds the wire to the charge controller.

Refer to the technical specifications for max wire sizes on the controller and for the maximum amperage going through wires.

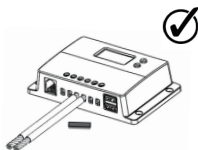
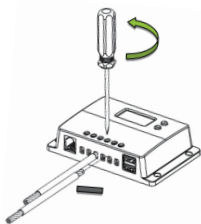
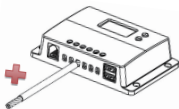
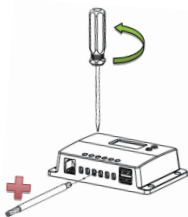
Wiring**■ Battery**

■ Solar Panel

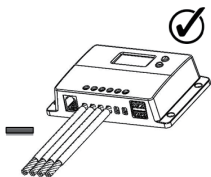
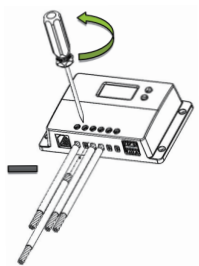
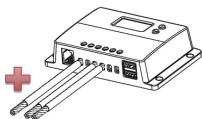
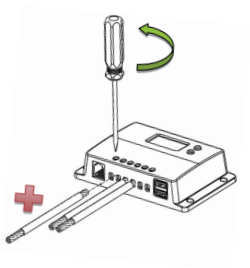

■ Load

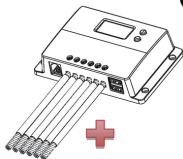
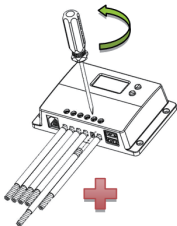
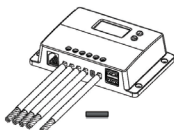
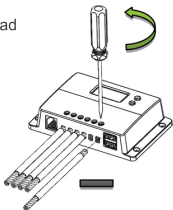

■ Bluetooth Module Communication (optional)

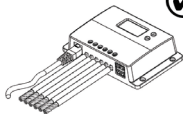
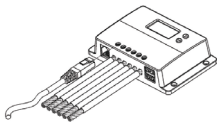

Mounting Recommendations

WARNING

Never install the controller in a sealed enclosure with flooded batteries. Gas can accumulate and there is a risk of explosion.

- 1. Choose Mounting Location**—place the controller on a vertical surface protected from direct sunlight, high temperatures, and water. Make sure there is good ventilation.
- 2. Check for Clearance**—verify that there is sufficient room to run wires, as well as clearance above and below the controller for ventilation. The clearance should be at least 6 inches (150mm).
- 3. Mark Holes**
- 4. Drill Holes**
- 5. Secure the charge controller.**

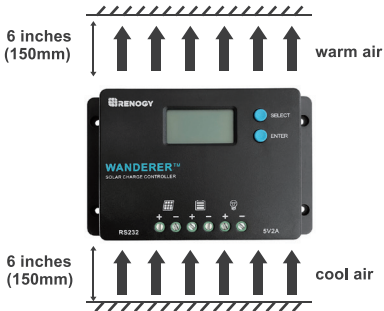

Operation

After connecting the battery to the charge controller, the controller will turn on automatically. Assuming normal operation, the charge controller will cycle through different displays. The user can adjust some parameters based on the display screen. The user can manually cycle through the display screens by using the “SELECT” and “ENTER” buttons.

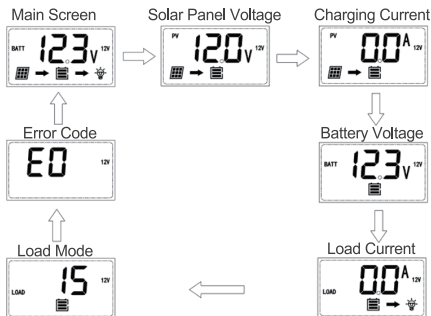

- **SELECT** Cycles forwards through the different display screens.
- **ENTER** Cycles backwards through the different select screens & Turn the load ON/OFF in the Manual Mode

Main Display

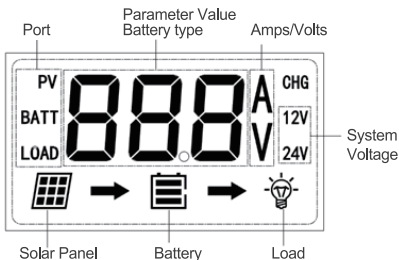

LCD Indicators



Icon or Value	State	Description
 →	Steady on	Solar Panels Charging Battery
	3 Bars Flashing	Battery Voltage (16.1V+)
	3 Bars	Battery Voltage (12.9V- 16.0V)
	2 Bars	Battery Voltage (12.5-12.8V)
	1 Bar	Battery Voltage (11.6-12.4V)
	No Bars	Battery Voltage (11.5V and below)
No Bars Flashing	Battery Voltage (10.9V and below)	
→ 	Steady on	Load is On

Programming Battery Type

To enter the battery programming settings hover over the Battery Voltage screen and press down the Enter button. When the battery type starts to flash press the Select button to cycle through the battery types and press Enter to finalize selection. When selecting the Lithium setting the user can change battery voltage from 12V to 24V and select the charging voltage.

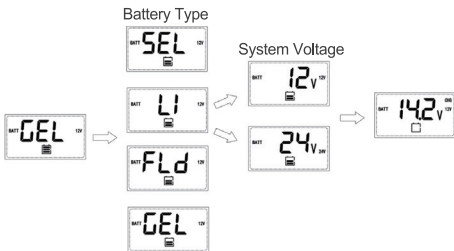

Programming Load Terminal

To enter the load programming settings hover over the Load Mode screen and hold the Enter button. When the number starts to flash press the Select button to cycle through the load types and press Enter to finalize selection.



Setting	Mode	Description
0	Automatic (On/Off)	The load will turn on at night when the solar panel is no longer producing any power after a short time delay. The load will turn off when the panel starts producing power.
1-14	Time control	When the panel is no longer producing power, the load will be ON for 1-14 hours or until the panel starts producing power.
15	Manual	In this mode, the user can turn the Load On/Off by pressing the Enter button at any time.
16	Test	Used to troubleshoot load terminal (No Time Delay). When voltage is detected load will be off and when no voltage is detected load will be on.
17	24Hr	The load will be on for 24 hours a day.

Wanderer Protections

Protection	Behavior
PV Array Short Circuit	When PV short circuit occurs, the controller will stop charging. Clear it to resume normal operation
PV Over current	The controller will limit the battery charging current to the maximum battery current rating. Therefore, an over-sized solar array will not operate at peak power.
Load Overload	If the current exceeds the maximum load current rating 1.05 times, the controller will disconnect the load. Overloading must be cleared up by reducing the load and restarting the controller.
Load Short Circuit	Fully protected against the load wiring short-circuit. Once the load short (more than quadruple rate current), the load short protection will start automatically. After 5 automatic load reconnect attempts, the faults must be cleared by restarting the controller.
PV Reverse Polarity	The controller will not operate if the PV wires are switched. Wire them correctly to resume normal controller operation.
Battery Reverse Polarity	The controller will not operate if the battery wires are switched. Wire them correctly to resume normal controller operation.

Error Codes

Error Number	Description
E0	No error detected
E01	Battery over-discharged
E02	Battery over-voltage
E04	Load short circuit
E05	Load overloaded
E06	Controller over-temperature
E08	PV input over-current
E10	PV over-voltage
E13	PV reverse polarity
E14	Battery reverse polarity

Maintenance

WARNING

Risk of Electric Shock! Make sure that **all** power is turned off before touching the terminals on the charge controller.

For best controller performance, it is recommended that these tasks be performed from time to time.

- Check that controller is mounted in a clean, dry, and ventilated area.
- Check wiring going into the charge controller and make sure there is no wire damage or wear.
- Tighten **all** terminals and inspect any loose, broken, or burnt up connections.
- Check to make sure none of the terminals have any corrosion, insulation damage, high temperature, or any burnt/discoloration marks.

Fusing

Fusing is a recommendation in PV systems to provide a safety measure for connections going from panel to controller and controller to battery. Remember to always use the recommended wire gauge size based on the PV system and the controller.

NEC Maximum Current for different Copper Wire Sizes									
AWG	16	14	12	10	8	6	4	2	0
Max. Current	10A	15A	20A	30A	55A	75A	95A	130A	170A

Fuse from Controller to Battery

**Controller to Battery Fuse =
Current Rating of Charge Controller**

Ex. Wanderer 10 = 10A fuse from Controller to Battery

Fuse from Solar Panel(s) to Controller

Ex. 200W; 2 X 100 W panels

**Parallel
Total Amperage = $I_{sc1} + I_{sc2} = (5.75A + 5.75A) * 1.56$**

Fuse = minimum of $11.5 * 1.56 = 17.94 = 18A$ fuse

Technical Specifications

Description	Parameter
Nominal Voltage	12V/24V Auto Recognition
Rated Charge Current	10A
Max. PV Input Voltage	50 VDC
USB Output	5V, 2A max
Self-consumption	≤10mA
Temperature Compensation Coefficient	-3mV/°C/2V
Operating Temperature	-25°C to +45°C -31°F to 113°F
Storage Temperature	-35°C to +80°C -31°F to 176°F
Enclosure	IP20
Terminals	Up to #12 AWG
Weight	0.27 lbs.
Dimensions	4.68 x 2.95 x 1.08 inches
Communication	RS232
Battery Type	Sealed (AGM), Gel, Flooded and Lithium

Battery Charging Parameters

All the coefficient is referred to 25°C

Battery	GEL	SEALED	FLOODED	LI(LFP)
High Voltage Disconnect	16 V	16 V	16 V	16 V
Over Voltage Reconnect	15.0 V	15.0 V	15.0 V	15.0 V
Equalization Voltage	---	14.6 V	14.6 V	---
Boost Voltage	14.2 V	14.4 V	14.6 V	14.2 V (User: 12.6-16V)
Float Voltage	13.8 V	13.8 V	13.8 V	---
Boost Return Voltage	13.2 V	13.2 V	13.2 V	13.2 V
Low Voltage Reconnect	12.6 V	12.6 V	12.6 V	12.6 V
Discharging Limit Voltage	10.8 V	10.8 V	10.8 V	10.8 V
Equalization Duration	---	2 hours	2 hours	---
Boost Duration	2 hours	2 hours	2 hours	---

Dimensions

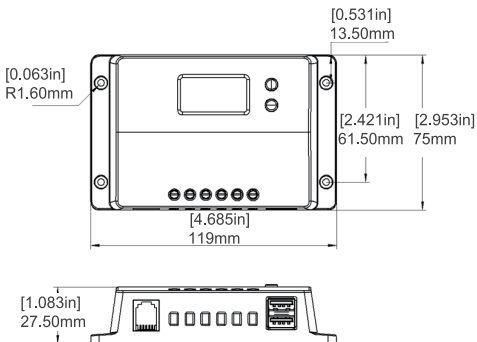



2775 E. Philadelphia St., Ontario, CA 91761
1-800-330-8678

Renogy reserves the right to change the
contents of this manual without notice.